

Differential pressure gauge with output signal

For the process industry, all-metal media chamber

Models DPGT43.100, DPGT43.160

WIKA data sheet PV 17.05



for further approvals see
page 5

intelliGAUGE®

Applications

- Acquisition and display of processes
- Output signals 4 ... 20 mA, 0 ... 20 mA, 0 ... 10 V for the transmission of process values to the control room
- For measuring points with increased differential overpressure
- Easy-to-read, analogue on-site display needing no external power
- Safety-related applications

Special features

- No configuration necessary due to "plug-and-play"
- Signal transmission per NAMUR
- Differential pressure measuring ranges from 0 ... 16 mbar
- Easy-to-read analogue display with nominal sizes 100 and 160
- Individual, non-linear characteristic curves (e.g. x^2 or \sqrt{x} for flow measurement)

Description

Wherever the process pressure has to be indicated locally and, at the same time, a signal transmission to the central control or remote centre is desired, the model DPGT43 intelliGAUGE® (patent, property right: e.g. DE 202007019025) can be used.

The model DPGT43 is based upon a model 732.51 high-quality, stainless steel pressure gauge with a nominal size of 100 or 160. The pressure measuring instrument is manufactured in accordance with EN 837-3.

These differential pressure gauges are made of highly corrosion-resistant stainless steel and feature an all-metal sealing of the media chamber.

Therefore no elastomer sealing elements are required, so that a better long-term leak tightness is ensured. A high overload safety is achieved by the all-metal construction and the close-fitting design of the pressure element.



Differential pressure gauge model DPGT43.100

The robust diaphragm measuring system produces a pointer rotation proportional to the pressure. An electronic angle encoder, proven in safety-critical automotive applications, determines the position of the pointer shaft – it is a non-contact sensor and therefore completely free from wear and friction. From this, the electrical output signal proportional to the pressure, e.g. 4 ... 20 mA, is produced. The measuring span (electrical output signal) is adjusted automatically along with the mechanical display, i.e. the scale over the full display range corresponds to 4 ... 20 mA. The electrical zero point can also be set manually.

The electronic WIKA sensor, integrated into the high-quality mechanical differential pressure gauge, combines the advantages of electrical signal transmission with a local mechanical display that remains readable during a power failure. An additional measuring point for mechanical pressure display can thus be saved.

Specifications

| Models DPGT43.100, DPGT43.160 | |
|--|---|
| Design | Process connections lower mount or lateral (option), highly corrosion-resistant solid metal design, measuring cell protected against unauthorised access. Overload resistance per EN 837-3 |
| Nominal size in mm | <ul style="list-style-type: none"> ■ 100 ■ 160 |
| Accuracy class | 1.6 Option: 1.0 |
| Scale ranges | 0 ... 16 mbar to 0 ... 250 mbar 0 ... 400 mbar to 0 ... 40 bar other units (e.g. psi, kPa) available or all other equivalent vacuum or combined pressure and vacuum ranges |
| Scale | Single scale Option: <ul style="list-style-type: none"> ■ Dual scale ■ Scale layout with individual non-linear characteristic curves |
| Pressure limitation | |
| Steady | Full scale value |
| Fluctuating | 0.9 x full scale value Observe the recommendations for the use of mechanical pressure measuring systems in accordance with EN 837-2 |
| Overload safety and max. working pressure (static pressure) | see table on page 3 |
| Connection location | Lower mount (radial) Option: lateral (right, left, front or back) |
| Process connection | <ul style="list-style-type: none"> ■ 2 x G ¼ B female ■ 2 x G ½ B male ■ 2 x ½ NPT male Other process connections via female or male threads on request |
| Restrictor | Without Option: Restrictor in the pressure port |
| Permissible temperature ¹⁾ | |
| Medium | -20 ... +100 °C Option: Medium temperature > 100 °C on request |
| Ambient | -20 ... +60 °C (with window from polycarbonate max. 80 °C) |
| Temperature effect | When the temperature of the measuring system deviates from the reference temperature (+20 °C): max. ±0.5 %/10 K of full scale value |
| Case | <ul style="list-style-type: none"> ■ Version S1 per EN 837: With blow-out device in case back ■ Safety version S3 per EN 837: With solid baffle wall (Solidfront) and blow-out back |
| Case filling | Without Option: With case filling |
| Venting of the media chamber | With scale ranges ≤ 0.25 bar Option: With scale ranges ≥ 0.4 bar |

1) For hazardous areas, the permissible temperatures of the output signal variant 2 will apply exclusively (see page 4). These must not be exceeded at the instrument either (for details see operating instructions). If necessary, measures for cooling (e.g. syphon, instrumentation valve, etc.) have to be taken.

Models DPGS43.100, DPGS43.160

Wetted materials

| | |
|--|--|
| Media chamber with process connection | Stainless steel 316Ti (1.4571) |
| Pressure elements | ≤ 0.25 bar: Stainless steel 316L > 0.25 bar: NiCr alloy (Inconel) |
| Bellows, venting of the media chamber (option) | Stainless steel 316Ti (1.4571) |

Non-wetted materials

| | |
|--|--|
| Movement | Brass |
| Dial | Aluminium, white, black lettering |
| Pointer | Aluminium, black |
| Case | Stainless steel, with blow-out device |
| Window | Laminated safety glass |
| Ring | Bayonet ring, stainless steel |
| Ingress protection per IEC/EN 60529 | IP54 ¹⁾ Option: IP65 with liquid filling |
| Installation | according to affixed symbols: ⊕ high pressure, ⊖ low pressure |
| Mounting | <ul style="list-style-type: none"> ■ Rigid measuring lines ■ Mounting holes in measuring flange Option: <ul style="list-style-type: none"> ■ Panel mounting flange ■ Instrument mounting bracket for wall or pipe mounting |

1) Ingress protection IP54 with safety version and lower back mount.

Overload safety and max. working pressure

| Scale ranges | Overload safety in bar either side max. | | Max. working pressure in bar (static pressure) | |
|----------------------------|---|--------|--|-----------------|
| | Standard | Option | Standard | Option |
| 0 ... 16 to 0 ... 40 mbar | 2.5 | - | 2.5 | 6 ²⁾ |
| 0 ... 60 to 0 ... 250 mbar | 2.5 | 6 | 6 | 10 |
| 0 ... 400 mbar | 4 | 40 | 25 | 40 |
| 0 ... 0.6 bar | 6 | 40 | 25 | 40 |
| 0 ... 1 bar | 10 | 40 | 25 | 40 |
| 0 ... 1.6 bar | 16 | 40 | 25 | 40 |
| 0 ... 2.5 to 0 ... 25 bar | 25 | 40 | 25 | 40 |

2) Accuracy class 2.5

| Models DPGT43.100 and DPGT43.160 | |
|---|---|
| Output signal | Variant 1: 4 ... 20 mA, 2-wire, passive, per NAMUR NE 43 Variant 2: 4 ... 20 mA, 2-wire, for hazardous areas Variant 3: 0 ... 20 mA, 3-wire Variant 4: 0 ... 10 V, 3-wire |
| Supply voltage U_B | DC 12 V < U_B ≤ 30 V (variant 1 and 3) DC 14 V < U_B ≤ 30 V (variant 2) DC 15 V < U_B ≤ 30 V (variant 4) |
| Influence of supply voltage | ≤ 0.1 % of full scale/10 V |
| Permissible residual ripple of U_B | ≤ 10 % ss |
| Permissible max. load R_A | Variants 1, 2, 3: $R_A \leq (U_B - 12 \text{ V})/0.02 \text{ A}$ with R_A in Ω and U_B in V, however max. 600 Ω Variant 4: $R_A = 100 \text{ k}\Omega$ |
| Effect of load (variant 1, 2, 3) | ≤ 0.1 % of full scale |
| Impedance at voltage output | 0.5 Ω |
| Electrical zero point | Through a jumper across terminals 5 and 6 (see operating instructions) |
| Long-term stability of electronics | < 0.3 % of full scale per year |
| Electr. output signal | ≤ 1 % of measuring span |
| Linear error | ≤ 1 % of measuring span (terminal method) |
| Resolution | 0.13 % of full scale (10 bit resolution at 360°) |
| Refresh rate (measuring rate) | 600 ms |
| Electrical connection | Cable socket PA 6, black Per VDE 0110 insulation group C/250 V Cable gland M20 x 1.5 Strain relief 6 screw terminals + PE for conductor cross-section 2.5 mm ² |
| Designation of connection terminals, 2-wire (variant 1 and 2) | <p>Do not use this terminal</p> <p>$U_B/+$</p> <p>+0 V/GND</p> <p>Terminals 3 and 4: For internal use only Terminals 5 and 6: Reset zero point</p> |
| Designation of connection terminals for 3-wire (variant 3 and 4), see operating instructions | |

Safety-related maximum values (variant 2)

| U_i | I_i | P_i | C_i | L_i |
|---------|--------|--------|-------|------------|
| DC 30 V | 100 mA | 720 mW | 11 nF | negligible |











Permissible temperature ranges (variant 2)

| T6 | T5 | T4 ... T1 |
|----------------|----------------|----------------|
| -20 ... +45 °C | -20 ... +60 °C | -20 ... +70 °C |

| T85°C | T100°C | T135°C |
|----------------|----------------|----------------|
| -20 ... +45 °C | -20 ... +60 °C | -20 ... +70 °C |

For further information on hazardous areas, see operating instructions.

Approvals

| Logo | Description | Country |
|---|---|-----------------------------|
|  | EU declaration of conformity <ul style="list-style-type: none"> ■ EMC directive ■ RoHS directive ■ ATEX directive (option) Hazardous areas <ul style="list-style-type: none"> - Ex ia Gas [II 2G Ex ia IIC T6/T5/T4 Gb] Dust [II 2D Ex ia IIIB T85 °C/T100 °C/T135 °C Db] | European Union |
|  | IECEx (option) Hazardous areas <ul style="list-style-type: none"> - Ex ia Gas [Ex ia IIC T6/T5/T4 Gb] Dust [Ex ia IIIB T85 °C/T100 °C/T135 °C Db] | International |
|  | EAC (option) <ul style="list-style-type: none"> ■ EMC directive ■ Pressure equipment directive ■ Low voltage directive ■ Hazardous areas | Eurasian Economic Community |
|  | GOST (option) Metrology, measurement technology | Russia |
|  | KazInMetr (option) Metrology, measurement technology | Kazakhstan |
| - | MTSCHS (option) Permission for commissioning | Kazakhstan |
|  | BelGIM (option) Metrology, measurement technology | Belarus |
|  | UkrSEPRO (option) Metrology, measurement technology | Ukraine |
|  | Ex Ukraine (option) Hazardous areas | Ukraine |
|  | Uzstandard (option) Metrology, measurement technology | Uzbekistan |
|  | NEPSI (option) Hazardous areas | China |
| - | CRN Safety (e.g. electr. safety, overpressure, ...) | Canada |

Certificates (option)

- 2.2 test report per EN 10204 (e.g. state-of-the-art manufacturing, indication accuracy)
- 3.1 inspection certificate per EN 10204 (e.g. indication accuracy)

Patents, property rights

Pointer measuring instrument with output signal
4 ... 20 mA (patent, property right: e.g. DE 202007019025,
US 2010045366, CN 101438333)

Approvals and certificates, see website

Accessories

- Sealings (model 910.17, see data sheet AC 09.08)
- Valves (models IV3x/IV5x, see data sheet AC 09.23)
- Diaphragm seal

Dimensions in mm

intelliGAUGE® models DPGT43.100 and DPGT43.160

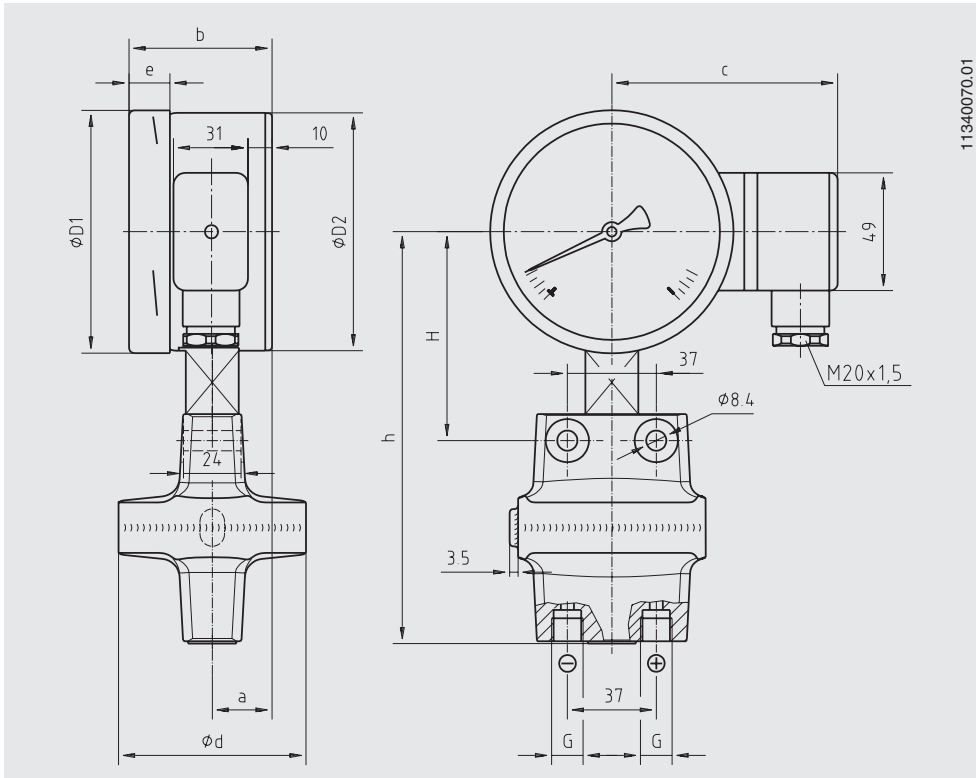

| NS | Scale range | Dimensions in mm | | | | | | | | | | Weight in kg |
|-----|------------------|------------------|------|-----|-----|----------------|----------------|----|-----|------|-----|--------------|
| | | a | b | c | d | D ₁ | D ₂ | e | G | h ±1 | H | |
| 100 | ≤ 0 ... 250 mbar | 25 | 59.5 | 94 | 140 | 101 | 99 | 17 | G ¼ | 161 | 90 | 2.7 |
| 100 | > 0 ... 250 mbar | 25 | 59.5 | 94 | 78 | 101 | 99 | 17 | G ¼ | 171 | 87 | 1.9 |
| 160 | ≤ 0 ... 250 mbar | 25 | 65 | 124 | 140 | 161 | 159 | 17 | G ¼ | 191 | 120 | 3.4 |
| 160 | > 0 ... 250 mbar | 25 | 65 | 124 | 78 | 161 | 159 | 17 | G ¼ | 201 | 117 | 2.4 |

Ordering information

Model / Nominal size / Scale range / Output signal / Connection location / Process connection / Scale layout (linear pressure or square root incrementation) / Max. working pressure (static pressure) / Options

© 11/2007 WIKA Alexander Wiegand SE & Co. KG, all rights reserved.
The specifications given in this document represent the state of engineering at the time of publishing.
We reserve the right to make modifications to the specifications and materials.

